

Standard Winch Size 8 Parts List

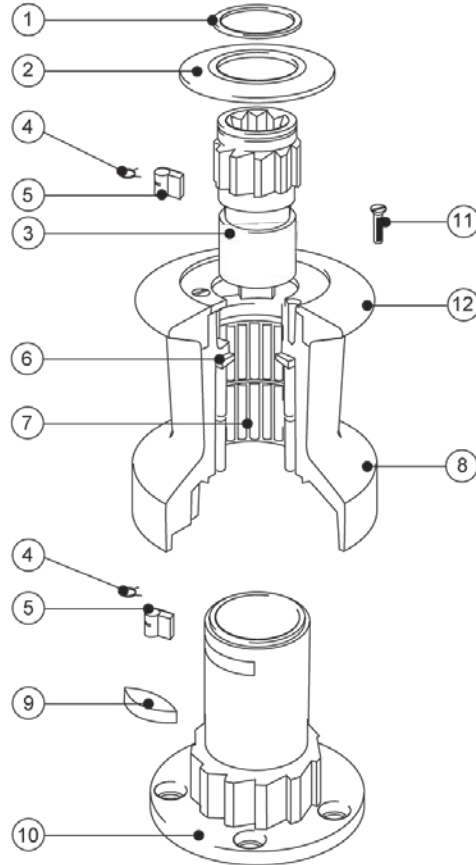

Item #	Description	Qty	Part Number
1-4-5-9	Circlip, Pawl springs, Pawls, Key	1	19700100
2	Top Cap	1	45001200
3	Spindle	1	15008003
4-5	Pawls & Pawl Springs (Part of Kit)	1	19700501
6	Drum washer	1	15008004
7	Roller bearing assembly	2	15008007
6	Drum - Alloy Finish	1	45001114
	Drum - Chrome Finish		15000650
10	Centre Stem	1	15008001
11	M5 x 12mm screw	3	15000527
12	Crown	1	45001109